

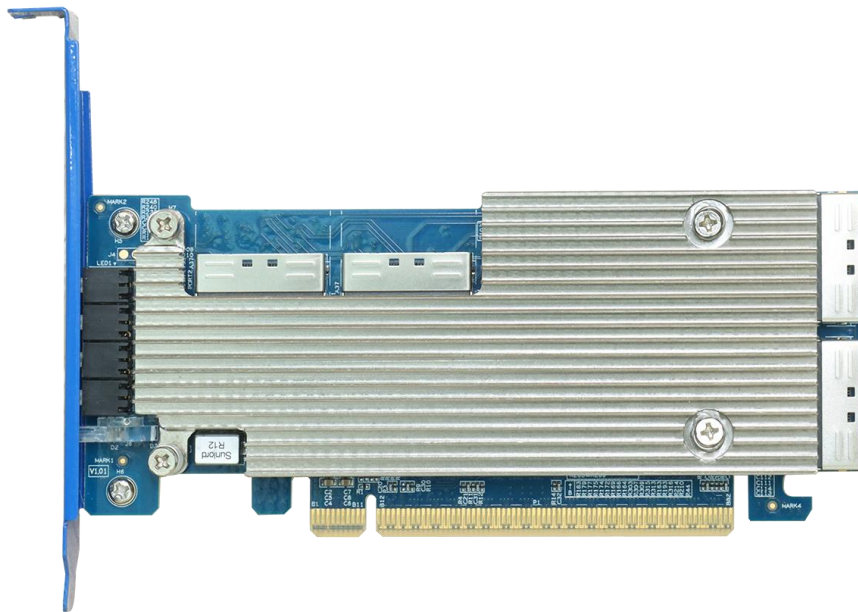

Rocket 1628A (R1628A)

NVMe Switch Adapter User Guide



V1.01 - May 22, 2024

Copyright 2024 HighPoint Technologies, Inc.

All rights reserved

Table of Contents

1. Overview	2
1.1. Key Features	2
1.1.1. FRU	3
1.1.2. Synthetic Hierarchy	3
1.1.3. Hardware Secure Boot	3
2. R1628A Hardware Description	4
2.1. R1628A Layout	4
2.2. PCIe Host Interface	6
2.3. Storage Interface	7
2.4. Basic Specifications	7
3. R1628A MCIO Connector	8
3.1. MCIO Connector Pin Designation	8
3.2. MCIO Connector Pinout	8
3.3. Backplane Connector Support	10
3.3.1. UBM Backplane	10
3.3.2. VPP Backplane	10
4. Cable Accessories	11
4.1. CIO8-8639-110	11
4.1.1. Cable Diagram	11
4.1.2. Cable Drawings and Pinouts	11
4.1.3. Cable Connection	12
4.2. CIO8-CIO8-110	13
4.2.1. Cable Diagram	13
4.2.2. Cable Drawings and Pinouts	13
4.2.3. Cable Connection	14
4.3. 8654-CIO8-110	15
4.3.1. Cable Diagram	15
4.3.2. Cable Drawings and Pinouts	15
4.3.3. Cable Connection	16
4.4. CIO8-1002-110	17
4.4.1. Cable Diagram	17
4.4.2. Cable Drawings and Pinouts	17
4.4.3. Cable Connection	18
5. R1628A Installation Instructions	19
6. Revision History	20
Version 1.01, May 22, 2024	20
Version 1.00, Apr. 25, 2024	20

1. Overview

The R1628A is the latest member of our PCIe Gen5 NVMe Switch Adapter product family.

HighPoint Rocket Series NVMe connectivity adapters address the needs of solution providers and system integrators that cater to vertical marketplaces for high-speed industrial, corporate, and media applications. They were designed for professional applications that demand uncompromised storage performance, scalability, and adaptability in a compact, easy-to-integrate package that is universally compatible with industry-standard x86-64 (Intel/AMD) platforms.

The R1628A's eight independent device ports can support U.2/U.3/E3.S NVMe SSDs via versatile cabling solutions.

All major Windows operating systems and current distributions of Linux natively support the R1628A. You won't need to juggle a series of device drivers, install a complex software suite, or master a specialized management interface. Your NVMe SSDs will be automatically recognized and can be prepped and mounted using the operating system's standard tool set.

1.1. Key Features

- Dedicated PCIe 5.0 x16 host interface
- Support data transfer rate 64GB/s
- Provide four internal MCIO (SFF-1016 8x) connectors
- Support eight dedicated U.2/U.3/E3.S NVMe devices
- Complies with SFF-9402 standard
- Provide a full-height bracket and a low-profile bracket
- True NVMe Hot-Plug & Hot-Swap capability
- FRU Inventory support
- Downstream port containment
- Read tracking
- Synthetic hierarchy
- Software Secure Boot
- Hardware Secure Boot
- Out-Of-band Support - BMC Support
- Complies with SFF-TA-1005 specification for Universal Backplane Management (UBM)
- Support VPP Backplane
- Support LED Management
- Support all the operating systems with a native NVMe driver

1.1.1. FRU

The *Field Replacement Unit (FRU)* ensures smooth operation and efficient maintenance of complex systems. The unit is designed to house and protect vital product data (VPD).

Information fields within a VPD resource type contain a three-byte header and some data. The three-byte header contains a two-byte keyword and a one-byte length. A keyword is a two-character (ASCII) mnemonic that uniquely identifies the information in the field. The last byte of the header is binary and represents the length value (in bytes) of the following data.

In the event of a hardware failure, the *FRU* can be quickly replaced, returning the device to a fully functional state without requiring extensive diagnostics or data recovery. This reduces downtime and minimizes the possibility of data loss, ensuring that critical operations can continue uninterrupted.

The following table describes the details and descriptions of the VPD.

Table 1: Details and Descriptions of the VPD

Key Word	Details	Descriptions
PN	AIC Part Number	This keyword is an extension to the Device ID (or Subsystem ID) in the Configuration Space header.
EC	Engineering Change Level	The characters are alphanumeric and represent the engineering change level for this add-in card.
MN	Manufacture ID	This keyword is provided as an extension to the Vendor ID (or Subsystem Vendor ID) in the Configuration Space header. This allows vendors to identify an additional level of detail regarding the sourcing of this device.
SN	Serial Number	The characters are alphanumeric and represent the unique add-in card Serial Number.
Vx	Vendor Specific	This is a vendor-specific item, and the characters are alphanumeric. The keyword's second character (x) can be 0 through 9 or A through Z. V0 indicates the Vendor Name V1 indicates the Main Chip

1.1.2. Synthetic Hierarchy

A synthetic hierarchy can be created to isolate the host from these physical PCIe topology changes and errors.

1.1.3. Hardware Secure Boot

The secure boot feature permits only authenticated firmware to execute. The switch boots the root of the trusted firmware from the internal boot ROM (IBR) and uses that firmware to authenticate the external firmware stored in the SPI flash and prevent the execution of unauthenticated code.

2. R1628A Hardware Description

2.1. R1628A Layout

The layout of the R1628A is presented in two parts.

- **Front View**

The following figure shows the key components of the R1628A.

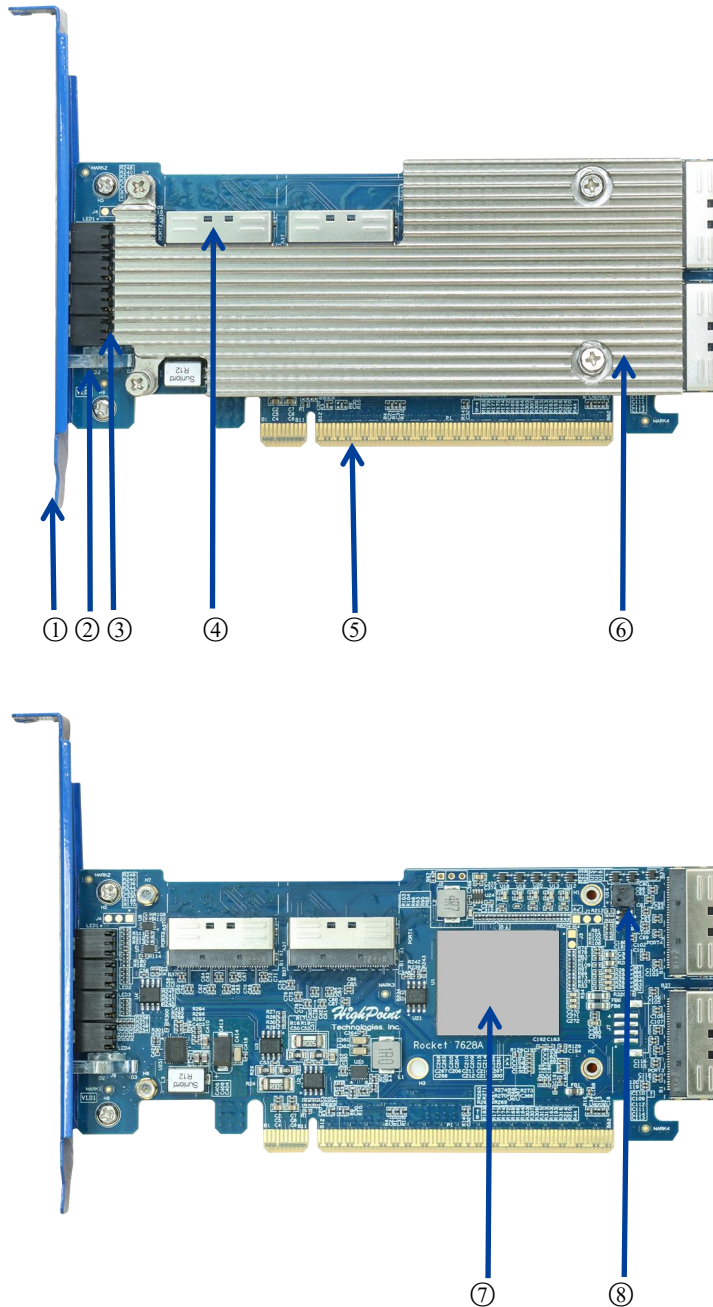

The following table describes the key components of the R1628A.

Table 2: Key component of the R1628A

Number	Type	Description
①	Bracket	Full-height bracket (optional low-profile bracket included). The R1628A is secured to the chassis by a bracket.
②	RGB	Status LED and Fault LED. <ul style="list-style-type: none"> ● Status LED -- The state of R1628A PCIe bandwidth ● Fault LED -- The state of the Broadcom chipset temperature.
③	LED	Eight SSD LED. SSD LED indicates the state of SSD bandwidth.
④	Storage Interface	Four MCIO (SFF-1016 8x) internal connectors. Connect the R1628A by cable to the storage devices.
⑤	PCIe Host Interface	PCIe 5.0 x16 host interface. The interface between the R1628A and the host system. With the PCIe interface, this connector provides power to the board.
⑥	Cooling System	Passive Heatsink They are used to dissipate heat from electronic components prone to heat generation.
⑦	Chip	Broadcom PEX 89048 chip.
⑧	Beeper	Only to be used for field testing.





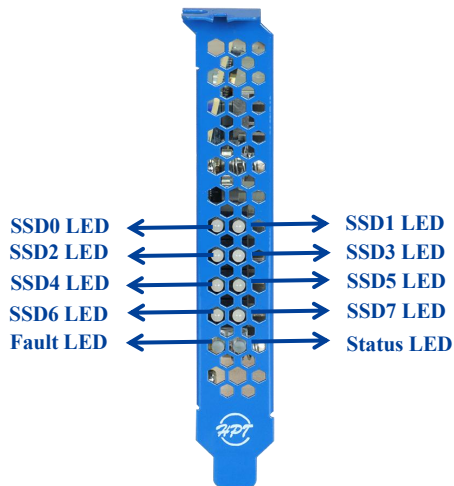







● **LED View**

The following figure shows the LED Indicators of the R1628A.



The following table describes the SSD LED, Status LED, and Fault LED of the R1628A.

Table 3: LED Indicators of the R1628A

LED	Color	Status	Description
SSD LED		OFF	The R1628A is powered off, or the SSD is not detected.
		Solid Green	The SSD is detected.
		Solid Red	The SSD has failed.
Status LED		OFF	The R1628A is powered off.
		Interval Flash Blue	The LED blinks blue twice in the first second, then goes out for one second and continues to cycle this process. This indicates the R1628A's bandwidth is PCIe 5.0 x16.
		Interval Flash Green	The LED blinks green twice in the first second, then goes out for one second and continues to cycle this process. This indicates the R1628A's bandwidth is PCIe 5.0 x8 or PCIe 4.0 x16.
		Interval Flash Yellow	The LED blinks yellow twice in the first second, then goes out for one second and continues to cycle this process. This indicates the R1628A's bandwidth is PCIe 5.0 x4, PCIe 4.0 x8, or PCIe 3.0 x16.
		Interval Flash Cyan	The LED blinks cyan twice in the first second, then goes out for one second and continues to cycle this process. This indicates the R1628A's bandwidth is PCIe 4.0 x4 or PCIe 3.0 x8.
		Interval Flash White	The LED blinks white twice in the first second, then goes out for one second and continues to cycle this process. This indicates the R1628A's bandwidth is PCIe 3.0 x4.
		Interval Flash Red	The LED blinks red twice in the first second, then goes out for one second and continues to cycle this process. This indicates the R1628A's bandwidth does not appear as above.
Fault LED		OFF	The R1628A is powered off.
		Fast Flash Red	The LED blinks red at 4 Hz to indicate that the Broadcom chipset temperature has exceeded the recommended temperature threshold (105°C)

2.2. PCIe Host Interface

The R1628A's PCIe 5.0 host interface provides maximum transmission. Other PCIe host interface features include the following:

- 16-lane PCIe host interface
- Support of x16 link width
- 16-lane aggregate bandwidth of up to 64GB/s

2.3. Storage Interface

The R1628A has 4 MCIO (SFF-1016 8x) interfaces. Other storage interface features include the following:

- Dedicated PCIe 5.0 x4 per port
- Supports up to eight NVMe devices (up to x4 lanes, U.2/U.3/E3.S media)
- Data transfer at 16 GB/s

2.4. Basic Specifications

The following table describes the basic specifications of the R1628A.

Table 4: Basic Specifications of R1628A

Model		R1628A
Form Factor		LP-MD2, Single Width
Weight		340g
Dimension	Length	6.102"
	Height	2.712"
Power consumption		16.26W
Power supply		PCIe: 12V($\pm 8\%$), 3.3V ($\pm 8\%$)
Work temperature		+5°C ~ +55°C
Storage temperature		-20°C ~ +80°C
MTBF (Mean Time Before Failure)		> 5,000,000 hours at 40°C

3. R1628A MCIO Connector

3.1. MCIO Connector Pin Designation

The R1628A has four x8 MCIO connectors, each designated A and B. It follows the SFF-9402 standard for connector sideband signal assignments.

The following figure shows the MCIO connector pin designation.

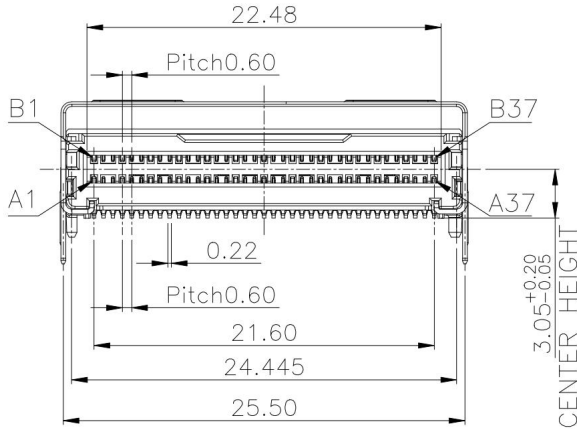

3.2. MCIO Connector Pinout

The following table defines the R1628A's MCIO connector pinouts.

Table 5: MCIO Connector Pinouts

Pin	Name	Pin	Name
A1	GND	B1	GND
A2	PERp0	B2	PETp0
A3	PERn0	B3	PETn0
A4	GND	B4	GND
A5	PERp1	B5	PETp1
A6	PERn1	B6	PETn1
A7	GND	B7	GND
A8	BP_TYPEA(VSPA)	B8	2W-CLKA
A9	CWAKEA#,OBFFA(VSPA)	B9	2W-DATAA
A10	Sideband2	B10	Sideband1
A11	REFCLKA+(VSPA+)	B11	PERSTA#(VSPA)
A12	REFCLKA-(VSPA-)	B12	CPRSNTA#(VSPA)

A13	GND	B13	GND
A14	PERp2	B14	PETp2
A15	PERn2	B15	PETn2
A16	GND	B16	GND
A17	PERp3	B17	PETp3
A18	PERn3	B18	PETn3
A19	GND	B19	GND
A20	PERp4	B20	PETp4
A21	PERn4	B21	PETn4
A22	GND	B22	GND
A23	PERp5	B23	PETp5
A24	PERn5	B24	PETn5
A25	GND	B25	GND
A26	BP_TYPEB(VSPB)	B26	2W-CLKB(VSPB)
A27	CWAKEB#,OBFFB(VSPB)	B27	2W-DATAB(VSPB)
A28	Sideband4	B28	Sideband3
A29	REFCLKB+(VSPB+)	B29	PERSTB#(VSPB)
A30	REFCLKB-(VSPB-)	B30	CPRSNTB#(VSPB)
A31	GND	B31	GND
A32	PERp6	B32	PETp6
A33	PERn6	B33	PETn6
A34	GND	B34	GND
A35	PERp7	B35	PETp7
A36	PERn7	B36	PETn7
A37	GND	B37	GND

3.3. Backplane Connector Support

The R1628A supports the industry-standard SFF-TA-1005 Specification for Universal Backplane Management (UBM). UBM provides the following key features:

- Reports the backplane capabilities, including the following:
 - NVMe drive widths
 - Maximum speeds
 - Dual-port support
 - Support for drive power enable and disable (PWDIS)
- Supports cable order independence
 - Disk LED control and slot ID are not dependent on cable order
- Enables disk hot-plug insertion

3.3.1. UBM Backplane

The SFF-TA-1005 (UBM) standard-compliant backplanes are designed to transmit slot numbers to the R1628A automatically. This innovation eliminates the need to manually configure cables between the R1628A and the backplane connector, optimizing cable flexibility.

Most backplanes use x4 or x8 host connectors. Each x8 connector has an "A" side and a "B" side.

3.3.2. VPP Backplane

The R1628A supports the legacy implementation of Virtual Pin Port (VPP) backplane management. The cables must be connected according to the desired slot enumeration to identify the slots correctly. Connect the MCIO connector of the R1628A to the backplane via the cable.

4. Cable Accessories

A wide selection of flexible cabling options is available for the R1628A, which enable the NVMe Switch Adapter to mix configurations of U.2/U.3/E3.S NVMe SSDs via SFF-8639, SFF-8654, SFF-TA-1002, and MCIO connectors.

The following sections indicate the cable pinout and connection diagram for supported cable accessories.

4.1. CIO8-8639-110

MCIO (x8) Host to SFF-8639 Device cable with a 15-pin SATA power connector. Each cable supports two U.2 NVMe SSDs. Length 1M.

4.1.1. Cable Diagram

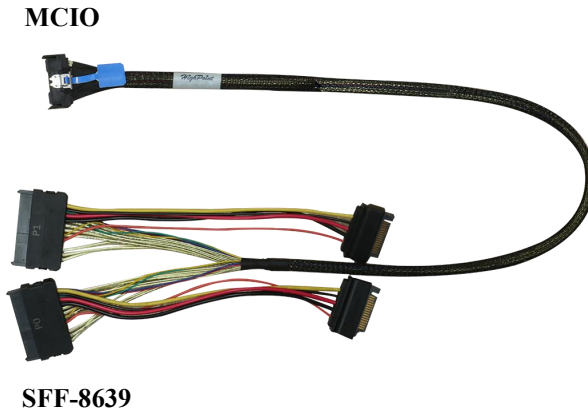

4.1.2. Cable Drawings and Pinouts

The following figure shows the pinout for the HighPoint CIO8-8639-110 cable, one x8 MCIO to two x4 SFF-8639 connection.

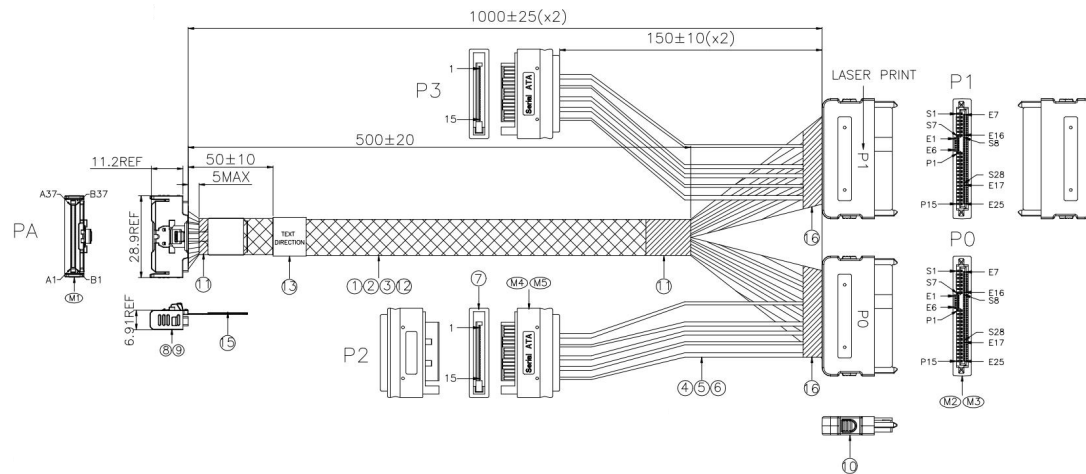

WIRING TABLE

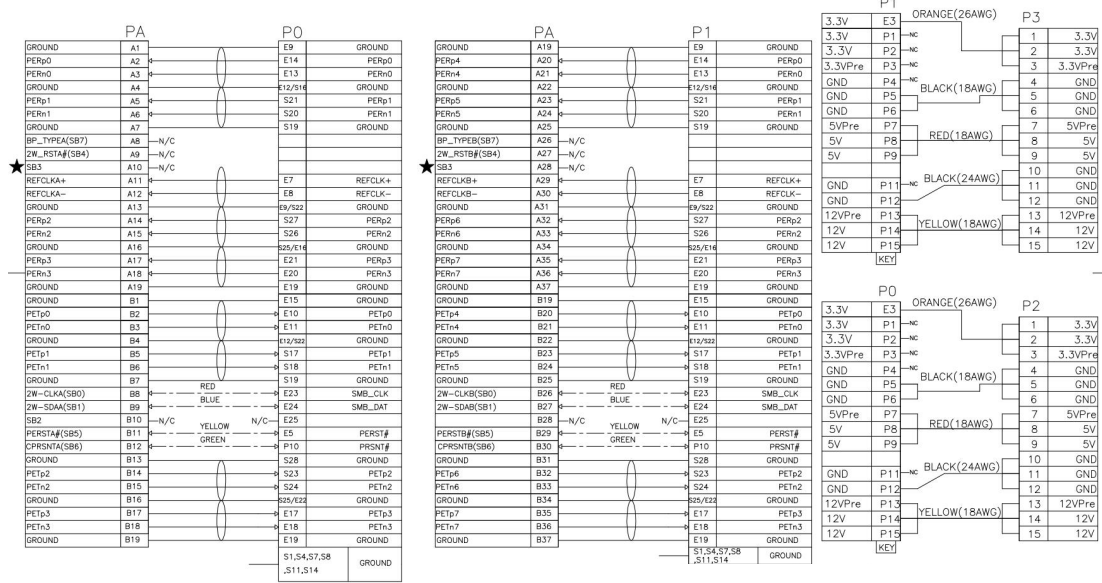

4.1.3. Cable Connection

The following steps show the connection of a U.2 SSD to the R1628A using the CIO8-8639-110 cable.

1. Connect the SFF-8639 connector of the CIO8-8639-110 cable to the NVMe SSD, and connect the 15-pin SATA power connector to the power supply.

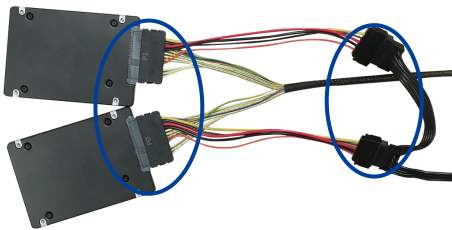

2. Connect the SFF-8639 connector of the CIO8-8639-110 cable to the R1628A.

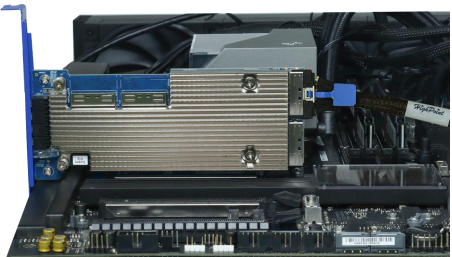

4.2. CIO8-CIO8-110

MCIO Host to MCIO Device cable. Each cable can host up to two NVMe SSDs. Length 1M.

4.2.1. Cable Diagram

MCIO



MCIO

4.2.2. Cable Drawings and Pinouts

The following figure shows the pinout for the HighPoint CIO8-CIO8-110 cable, one x8 MCIO to one x8 MCIO connection.

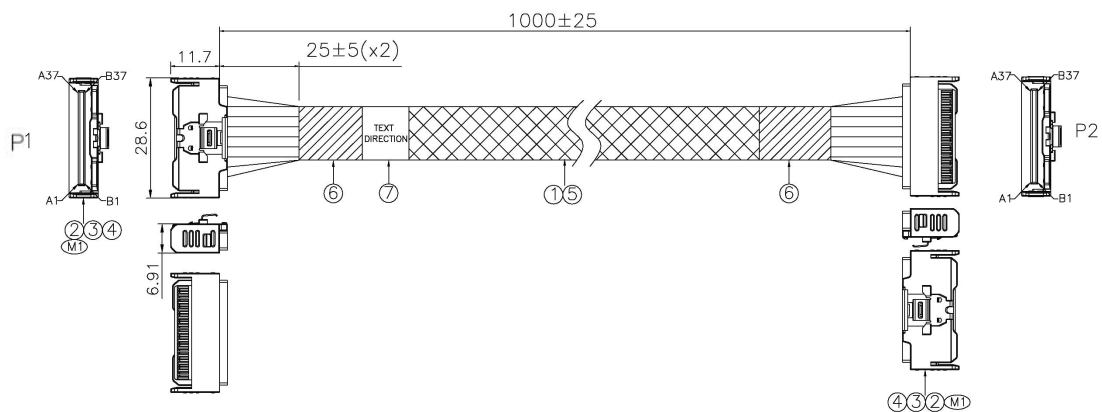

WIRING TABLE

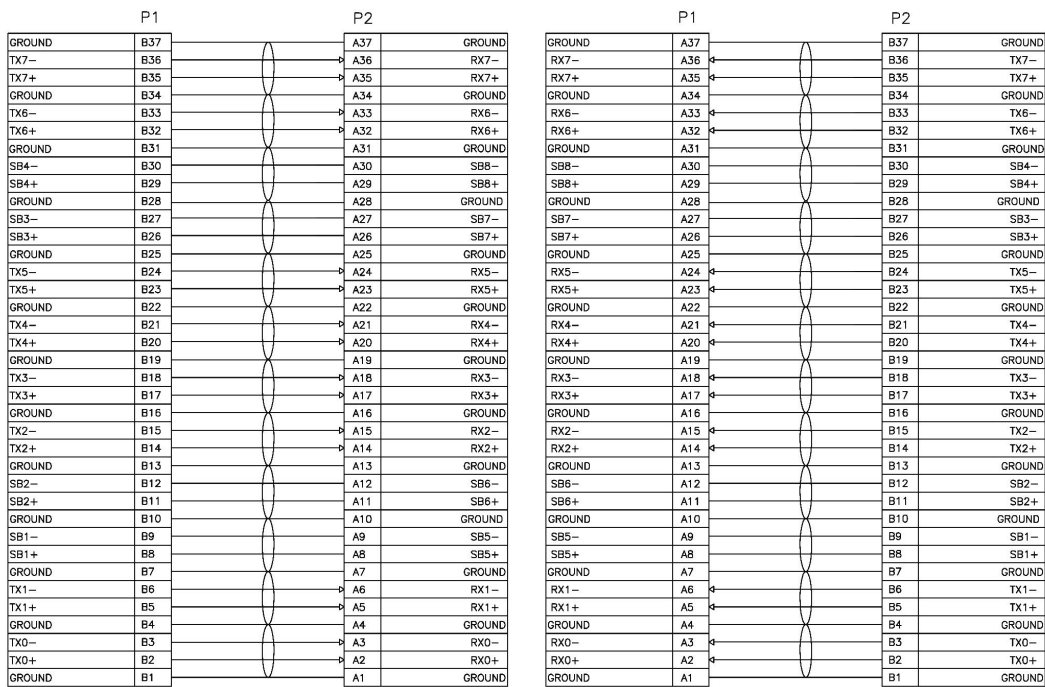

4.2.3. Cable Connection

The following steps show the connection of the backplane to the R1628A using the CIO8-CIO8-110 cable.

1. Connect the MCIO connector of the CIO8-CIO8-110 cable to the backplane.

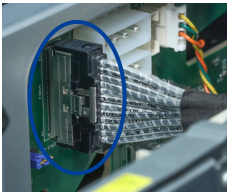

2. Connect the other MCIO connector of the CIO8-CIO8-110 cable to the R1628A.

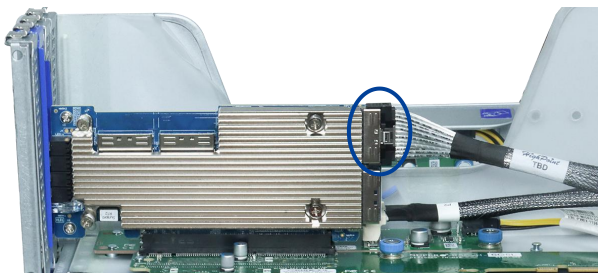

4.3. 8654-CIO8-110

MCIO Host to SFF-8654 Device cable. Each cable can host up to two NVMe SSDs. Length: 1M.

4.3.1. Cable Diagram

SFF-8654



MCIO

4.3.2. Cable Drawings and Pinouts

The following figure shows the HighPoint 8654- CIO8-110 cable pinout, one x8 MCIO to one x8 SFF-8654 connection.

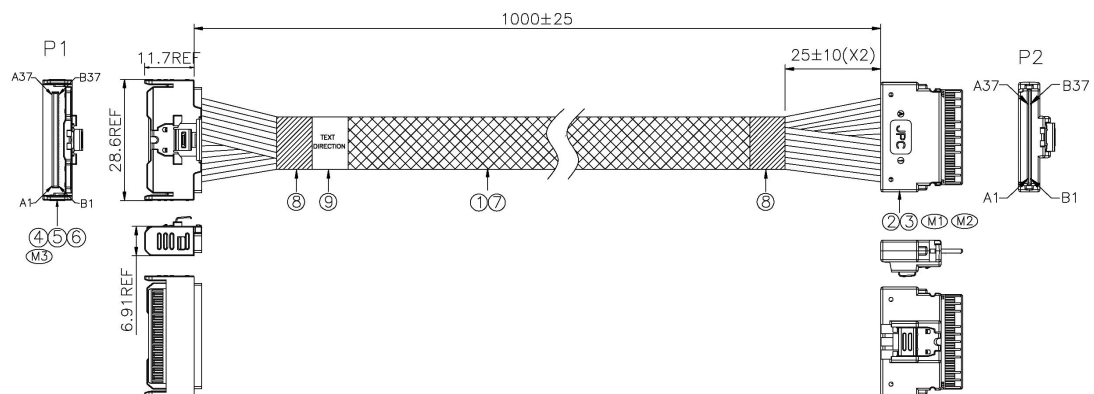

WIRING TABLE

P1			P2			P1			P2		
GROUND	B37	B37	A37	A37	GROUND	GROUND	A37	A37	B37	B37	GROUND
TX7-	B36	B36	A36	A36	RX7-	RX7-	A36	A36	B36	B36	TX7-
TX7+	B35	B35	A35	A35	RX7+	RX7+	A35	A35	B35	B35	TX7+
GROUND	B34	B34	A34	A34	GROUND	GROUND	A34	A34	B34	B34	GROUND
TX6-	B33	B33	A33	A33	RX6-	RX6-	A33	A33	B33	B33	TX6-
TX6+	B32	B32	A32	A32	RX6+	RX6+	A32	A32	B32	B32	TX6+
GROUND	B31	B31	A31	A31	GROUND	GROUND	A31	A31	B31	B31	GROUND
SIDEBAND	B30	B30	A30	A30	SIDEBAND	SIDEBAND	A30	A30	B30	B30	SIDEBAND
SIDEBAND	B29	B29	A29	A29	SIDEBAND	SIDEBAND	A29	A29	B29	B29	SIDEBAND
GROUND	B28	B28	A28	A28	GROUND	GROUND	A28	A28	B28	B28	GROUND
SIDEBAND	B27	B27	A27	A27	SIDEBAND	SIDEBAND	A27	A27	B27	B27	SIDEBAND
SIDEBAND	B26	B26	A26	A26	SIDEBAND	SIDEBAND	A26	A26	B26	B26	SIDEBAND
GROUND	B25	B25	A25	A25	GROUND	GROUND	A25	A25	B25	B25	GROUND
TX5-	B24	B24	A24	A24	RX5-	RX5-	A24	A24	B24	B24	TX5-
TX5+	B23	B23	A23	A23	RX5+	RX5+	A23	A23	B23	B23	TX5+
GROUND	B22	B22	A22	A22	GROUND	GROUND	A22	A22	B22	B22	GROUND
TX4-	B21	B21	A21	A21	RX4-	RX4-	A21	A21	B21	B21	TX4-
TX4+	B20	B20	A20	A20	RX4+	RX4+	A20	A20	B20	B20	TX4+
GROUND	B19	B19	A19	A19	GROUND	GROUND	A19	A19	B19	B19	GROUND
TX3-	B18	B18	A18	A18	RX3-	RX3-	A18	A18	B18	B18	TX3-
TX3+	B17	B17	A17	A17	RX3+	RX3+	A17	A17	B17	B17	TX3+
GROUND	B16	B16	A16	A16	GROUND	GROUND	A16	A16	B16	B16	GROUND
TX2-	B15	B15	A15	A15	RX2-	RX2-	A15	A15	B15	B15	TX2-
TX2+	B14	B14	A14	A14	RX2+	RX2+	A14	A14	B14	B14	TX2+
GROUND	B13	B13	A13	A13	GROUND	GROUND	A13	A13	B13	B13	GROUND
SIDEBAND	B12	B12	A12	A12	SIDEBAND	SIDEBAND	A12	A12	B12	B12	SIDEBAND
SIDEBAND	B11	B11	A11	A11	SIDEBAND	SIDEBAND	A11	A11	B11	B11	SIDEBAND
GROUND	B10	B10	A10	A10	GROUND	GROUND	A10	A10	B10	B10	GROUND
SIDEBAND	B9	B9	A9	A9	SIDEBAND	SIDEBAND	A9	A9	B9	B9	SIDEBAND
SIDEBAND	B8	B8	A8	A8	SIDEBAND	SIDEBAND	A8	A8	B8	B8	SIDEBAND
GROUND	B7	B7	A7	A7	GROUND	GROUND	A7	A7	B7	B7	GROUND
TX1-	B6	B6	A6	A6	RX1-	RX1-	A6	A6	B6	B6	TX1-
TX1+	B5	B5	A5	A5	RX1+	RX1+	A5	A5	B5	B5	TX1+
GROUND	B4	B4	A4	A4	GROUND	GROUND	A4	A4	B4	B4	GROUND
TX0-	B3	B3	A3	A3	RX0-	RX0-	A3	A3	B3	B3	TX0-
TX0+	B2	B2	A2	A2	RX0+	RX0+	A2	A2	B2	B2	TX0+
GROUND	B1	B1	A1	A1	GROUND	GROUND	A1	A1	B1	B1	GROUND

4.3.3. Cable Connection

The following steps show the connection of the backplane to the R1628A using the 8654-CIO8-110 cable.

1. Connect the SFF-8654 connector of the 8654-CIO8-110 cable to the backplane.

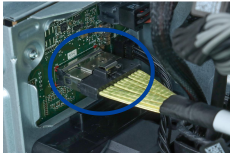

2. Connect the MCIO connector of the 8654-CIO8-110 cable to the R1628A.



4.4. CIO8-1002-110

MCIO Host to SFF-TA-1002 Device cable. Each cable can host up to two NVMe SSDs. Length 1M.

4.4.1. Cable Diagram

SFF-TA-1002

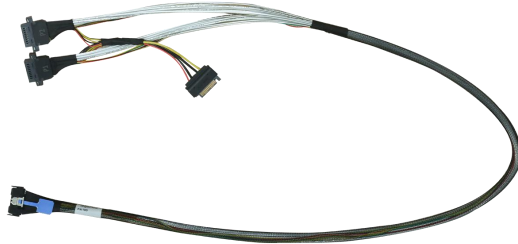

MCIO

4.4.2. Cable Drawings and Pinouts

The following figure shows the pinout for the HighPoint CIO8-1002-110 cable, one x8 MCIO to two x4 SFF-TA-1002 connection.

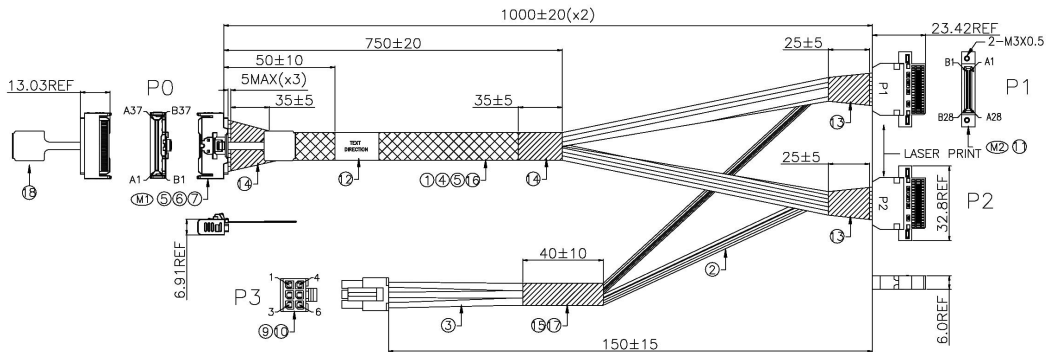

★ WIRING TABLE

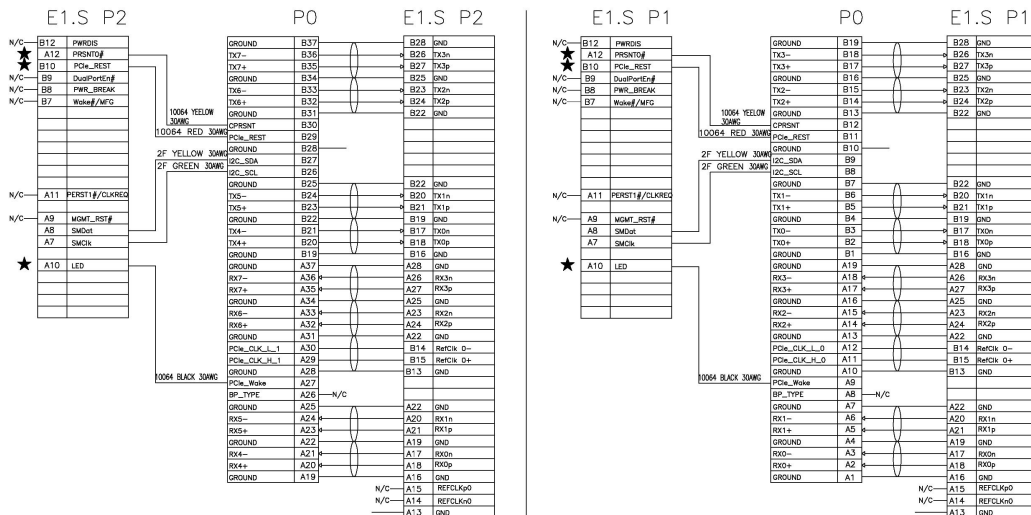

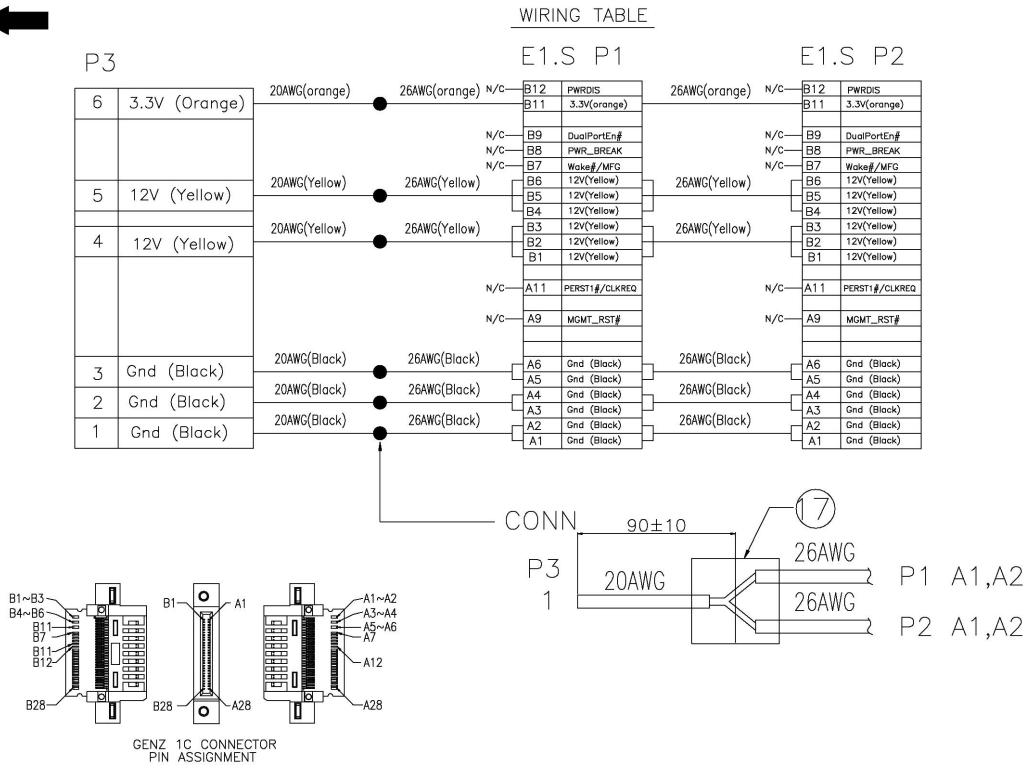

4.4.3. Cable Connection

The following steps show the connection of an NVMe SSD to the R1628A using the CIO8-1002-110 cable.

1. Connect the P1/P2 side of the SFF-TA-1002 connector to the front of the NVMe SSD, and connect the 15-pin SATA power connector to the power supply.

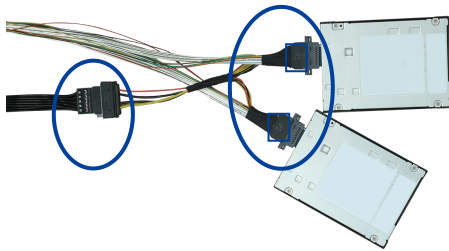

2. Connect the MCIO connector of the CIO8-1002-110 cable to the R1628A.

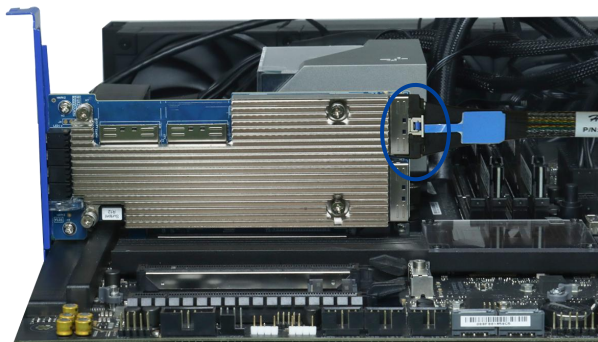

5. R1628A Installation Instructions

The R1628A provides four MCIO connectors. These connectors accept a variety of HighPoint Certified Cable Accessories (see the Accessories section towards the end of this guide for more information). The following steps explain how to connect U.2 NVMe SSDs directly to the R1628A using HighPoint CIO8-8639-110 cable.

1. Use a wired ESD wrist strap that is properly grounded.
2. Unpack and remove the R1628A and check it for damage. If it appears damaged, please get in touch with HighPoint Technical Support.
3. Shut down the system and disconnect the AC power cord.
4. Align the R1628A to one of the motherboard's available PCIe slots. Press down gently but firmly to seat the R1628A correctly in the slot.

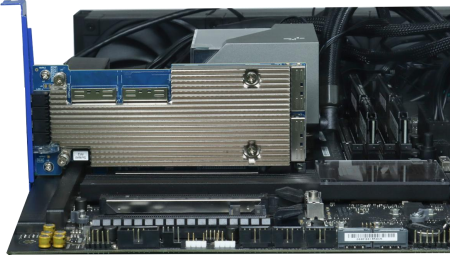

Note: Replace the full-height bracket on the R1628A with the optional low-profile bracket if required by your system.

5. Connect the SFF-8639 connector of the CIO8-8639-110 cable to the NVMe SSD, and connect the 15-pin SATA power connector to the power supply.

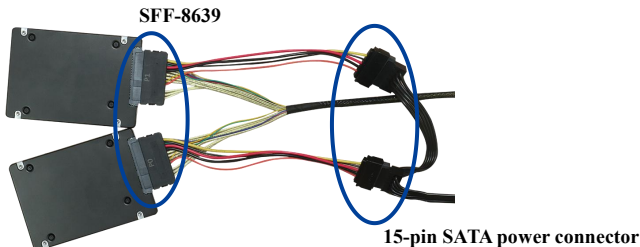

6. Connect the MCIO connector of the CIO8-8639-110 cable to the R1628A.

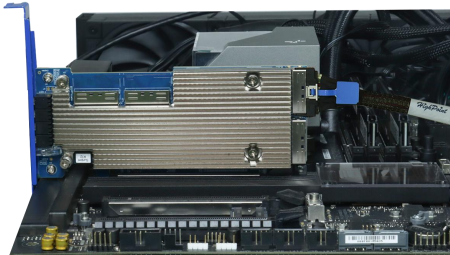

7. Connect the remaining NVMe SSDs to the R1628A as described above.
8. Turn on the power to the system.

Note: Please ensure the cables are securely connected to the R1628A's device ports and the NVMe SSDs or backplanes. Loose connections can lead to various problems, including instability, slower-than-expected performance, and dropped disks.

6. Revision History

Version 1.01, May 22, 2024

Update [Cable Accessories](#), Add cable CIO8-1002-110

Version 1.00, Apr. 25, 2024

Initial version.